

HOSE AND FITTING INDEX

STANDARD ALUMINUM FITTINGS

FEMALE O-RING	
3 BARB & BEADLOCK	447 - 448
MALE O-RING	
3 BARB & BEADLOCK	449
MALE INSERT O-RING	
3 BARB & BEADLOCK	450
SPLICERS	
3 BARB & BEADLOCK	451
WELD ON FITTINGS	
3 BARB & BEADLOCK	451

FORD SPRINGLOCK

SPRINGLOCK FITTINGS	452
---------------------	-----

FLARE

FLARE FITTINGS	453
----------------	-----

METRIC

METRIC FITTINGS	454
-----------------	-----

HOSE

REFRIGERANT HOSE STANDARD	455
---------------------------	-----

REDUCED BARRIER

REDUCED BARRIER HOSE	456
REDUCED BARRIER FITTINGS	456 - 457
STEEL FITTINGS	458 - 460
REDUCED BARRIER STEEL FITTINGS	461 - 462

SPECIALTY

SPECIALTY FITTINGS	463 - 464
RETROFIT FITTINGS	465

POA VALVE REPLACEMENT KITS

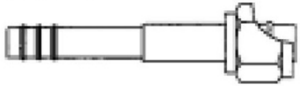
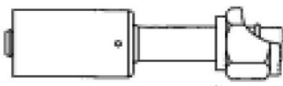
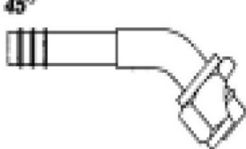
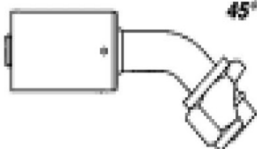
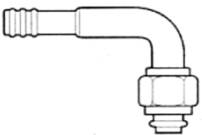
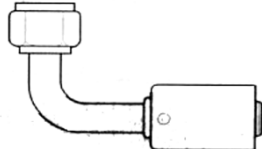

KITS	466 - 467
------	-----------

O-RING FITTINGS ALUMINUM

STANDARD 3 BARB FEMALE O-RING	PART NUMBER	HOSE SIZE	FITTING SIZE	PART NUMBER	BEADLOCK FEMALE O-RING
STRAIGHT 	45-2702	#6	3/8	45-3502	STRAIGHT 
	45-2703	#8	1/2	45-3503	
	45-2704	#10	5/8	45-3504	
	45-2705	#12	3/4	45-3505	
STEP UP/ STEP DOWN FEMALE O-RING	45-2730	#12	5/8	45-3506	STEP UP/ STEP DOWN FEMALE O-RING
	45-2731	#6	1/2	45-3507	
	45-2728	#8	3/8	45-3559	
	45-2729	#10	1/2	45-3561	
	45-3180	#10	3/4	45-3563	
		#8	#9	45-4320	DUAL O-RING
		#10	#11	45-4322	
		#12	#12	45-4324	
W / R-12 CHARGE PORT	45-3130	#6	#6	45-3565	W / R-12 CHARGE PORT
	45-3132	#8	#8	45-3567	
	45-3134	#10	#10	45-3569	
	NA	#12	#10	45-3571	
45° 	45-2706	#6	3/8	45-3508	45° 
	45-2707	#8	1/2	45-3509	
	45-2708	#10	5/8	45-3510	
	45-2709	#12	3/4	45-3511	
STEP UP/ STEP DOWN FEMALE O-RING	45-2732	#8	3/8	45-3577	STEP UP/ STEP DOWN FEMALE O-RING
	45-2733	#10	1/2	45-3579	
	45-2734	#12	5/8	45-3581	
		#8	#9	45-4326	DUAL O-RING
		#10	#11	43-2328	
		#12	#12	45-4330	
	45-3196	#6	#6	45-3583	W / R-12 CHARGE PORT
	45-3198	#8	#8	45-3585	
	45-3200	#10	#10	45-3587	
	N/A	#12	#12	45-3589	
	45-2710	#6	3/8	45-3512	
	45-2711	#8	1/2	45-3513	
	45-2712	#10	5/8	45-3514	
	45-2713	#12	3/4	45-3515	
STEP UP/ STEP DOWN FEMALE O-RING	45-2735	#8	3/8	45-3599	STEP UP/ STEP DOWN FEMALE O-RING
	45-2738	#6	1/2	45-3517	
	45-2736	#10	1/2	45-3601	
	45-2737	#12	5/8	45-3516	
	45-2739	#10	3/4	45-3603	
		#8	#9	45-4332	DUAL O-RING
		#10	#11	45-4334	
		#12	#12	45-4336	
W / R-12 CHARGE PORT	45-3136	#6	#6	45-3605	W / R-12 CHARGE PORT
	45-3138	#8	#8	45-3607	
	45-3140	#10	#10	45-3609	
	45-3142	#12	#10	45-3611	
	NA	#6	#8	45-3679	



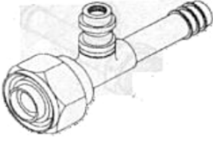
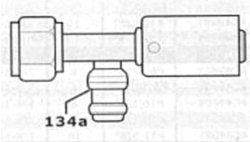

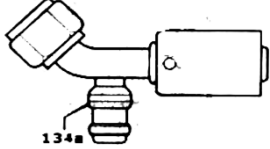
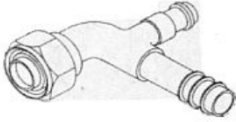
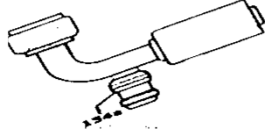
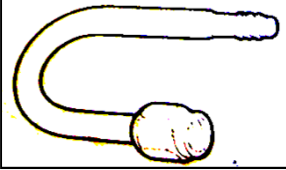
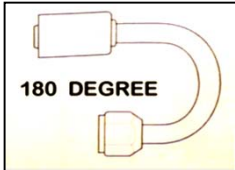
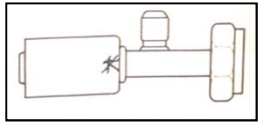
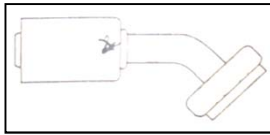
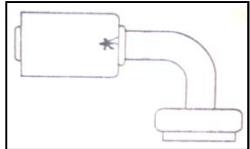
O-RING FITTINGS ALUMINUM

ALUMINUM O-RING FITTINGS

3 BARB FEMALE O-RING W/R134 CHARGING PORT	PART NUMBER	HOSE SIZE	FITTING SIZE	PART NUMBER	BEADLOCK FEMALE O-RING W/R134 CHARGING PORT
	45-3848 45-3849 45-3850 N/A 45-3851	#6 #8 #10 #12 #12	3/8 1/2 5/8 5/8 3/4	45-3572 45-3573 45-3574 45-3575 45-4707	
	N/A 45-3852 45-3853 45-3854	#6 #6 #8 #10 #12 #12	1/2 3/8 1/2 5/8 3/4 5/8	45-3677 45-3591 45-3593 45-3595 45-3712 45-3597	
	45-3856 45-3857 45-3858 45-3859	#6 #8 #10 #12	3/8 1/2 5/8 3/4	45-3612 45-3613 45-3614 45-4719	
STEP UP/ STEP DOWN FEMALE O-RING		#12 #6 #8 #10	5/8 3/8 1/2 5/8	45-3615 45-4023 45-4025 45-4027	STEP UP/ STEP DOWN FEMALE O-RING
FEMALE O-RING	PART NUMBER	HOSE SIZE	FITTING SIZE	PART NUMBER	FEMALE O-RING
	45-4807 45-3210 45-2740	#6 #8 #12	#6 #8 #12	45-3681 45-3683 45-3685	
		HOSE SIZE	FITTING SIZE	PART NUMBER	FEMALE TUBE-O-RING W/ R-12 SERVICE PORT
		#8 #10	TUBE-O TUBE-O	45-3687 45-3689	
		#8 #10	TUBE-O TUBE-O	45-3691 45-3693	
		#8 #10	TUBE-O TUBE-O	45-3695 45-3697	

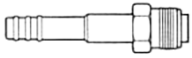

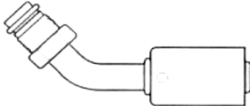
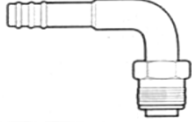
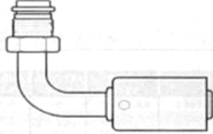
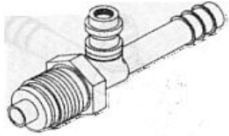
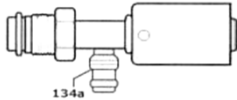
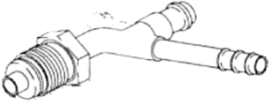
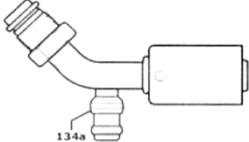

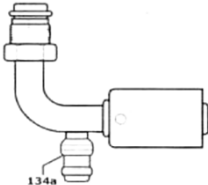

ALUMINUM O-RING FITTINGS

O-RING FITTINGS ALUMINUM

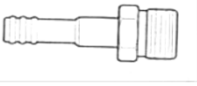
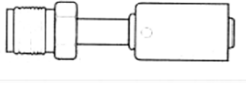

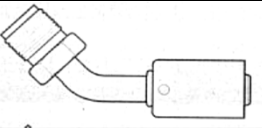
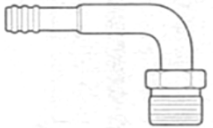

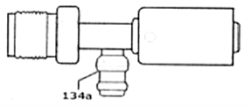
STANDARD 3 BARB MALE O-RING	PART NUMBER	HOSE SIZE	FITTING SIZE	PART NUMBER	BEADLOCK MALE O-RING
	45-2688	#6	3/8	45-3490	
	45-2689	#8	1/2	45-3491	
	45-2690	#10	5/8	45-3492	
	45-2691	#12	3/4	45-3493	
STEP UP/ STEP DOWN MALE O-RING	N/A	#12	1/2	45-3544	STEP UP/ STEP DOWN MALE O-RING
	45-2714	#8	3/8	45-3542	
	45-2715	#6	1/2	45-3545	
	45-2716	#10	1/2	45-3543	
	45-2717	#8	5/8	45-3547	
	45-2718	#12	5/8	N/A	
45-2719	#10	3/4	N/A		
	45-2693	#6	3/8	45-3494	
	45-2694	#8	1/2	45-3495	
	45-2695	#10	5/8	45-3496	
	45-2696	#12	3/4	45-3497	
STEP UP/ STEP DOWN MALE O-RING	45-2720	#6	1/2	45-3551	STEP UP/ STEP DOWN MALE O-RING
	45-2721	#8	3/8	45-3549	
	45-2722	#10	1/2		
	45-2698	#6	3/8	45-3498	
	45-2699	#8	1/2	45-3499	
	45-2700	#10	5/8	45-3500	
	45-2701	#12	3/4	45-3501	
STEP UP/ STEP DOWN MALE O-RING	45-2723	#8	3/8	45-3553	STEP UP/ STEP DOWN MALE O-RING
	45-2724	#6	1/2	45-3557	
	45-2725	#10	1/2	N/A	
	45-2726	#8	5/8	N/A	
	45-2727	#10	3/4	N/A	
	45-3194	#12	5/8	45-3555	
3 BARB MALE O-RING W/R134 CHARGING PORT	PART NUMBER	HOSE SIZE	FITTING SIZE	PART NUMBER	BEADLOCK MALE O-RING W/R134 CHARGING PORT
	45-3860	#6	3/8	45-4687	
	45-3861	#8	1/2	45-4689	
	45-3862	#10	5/8	45-4684	
	45-3863	#12	3/4	45-4686	
	45-3864	#6	3/8	45-4696	
	45-3865	#8	1/2	45-4698	
	45-3866	#10	5/8	45-4692	
	45-3867	#12	3/4	45-4694	
	45-3868	#6	3/8	45-4702	
	45-3869	#8	1/2	45-4704	
	45-3870	#10	5/8	45-4699	
	45-3871	#12	3/4	45-4701	

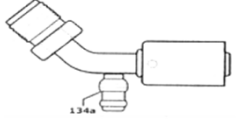
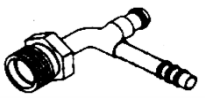
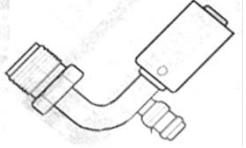
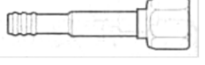
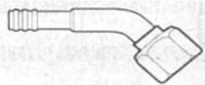
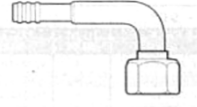
ALUMINUM O-RING FITTINGS

O-RING FITTINGS ALUMINUM

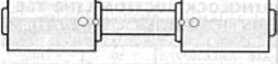
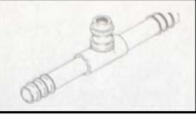
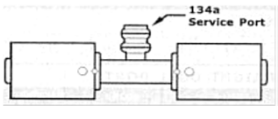
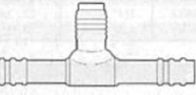
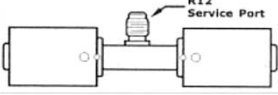
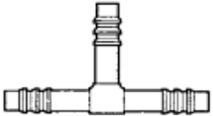
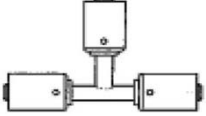
STANDARD 3 BARB MALE INSERT O-RING	PART NUMBER	HOSE SIZE	FITTING SIZE	PART NUMBER	BEADLOCK MALE INSERT O-RING
	45-2741 45-2746 45-2747 45-2745	#6 #8 #10 #12	3/8 1/2 5/8 3/4	45-3518 45-3519 45-3520 45-3521	
STEP UP/ STEP DOWN INSERT MALE O-RING	45-2742 45-4929 45-2743 45-2744	#8 #6 #10 #12	3/8 1/2 1/2 5/8		STEP UP/ STEP DOWN INSERT MALE O-RING
	45-2913 45-3206 45-3208 45-2751	#6 #8 #10 #12	3/8 1/2 5/8 3/4	45-3522 45-3523 45-3524	
STEP UP/ STEP DOWN INSERT MALE O-RING	45-2748 45-2749 45-2750	#8 #10 #12	3/8 1/2 5/8		STEP UP/ STEP DOWN INSERT MALE O-RING
	45-2752 45-2756 45-2902 45-2904	#6 #8 #10 #12	3/8 1/2 5/8 3/4	45-3525 45-3526 45-3527	
STEP UP/ STEP DOWN MALE O-RING	45-2753 45-2754 45-2755	#8 #10 #12	3/8 1/2 5/8		STEP UP/ STEP DOWN MALE O-RING
3 BARB MALE INSERT O-RING W/R134 CHARGING PORT	PART NUMBER	HOSE SIZE	FITTING SIZE	PART NUMBER	BEADLOCK MALE INSERT O-RING W/R134 CHARGING PORT
	45-1872 45-1873 45-1873 45-1874	#6 #8 #10 #12	3/8 1/2 5/8 3/4	45-4687 45-4689 45-4684 45-4686	
	45-1876 45-1877 45-1878 45-1879	#6 #8 #10 #12	3/8 1/2 5/8 3/4	45-4733 45-4735 45-2730 45-4731	
	45-1880 45-1801 45-1802 45-1803	#6 #8 #10 #12	3/8 1/2 5/8 3/4	45-4740 45-4742 45-4737 45-4738	
3 BARB FEMALE INSERT O-RING (GM ACCUMULATOR)	PART NUMBER	HOSE SIZE	FITTING SIZE	PART NUMBER	
	45-3116	#12	3/4		
	45-3118	#12	3/4		
	45-3120	#12	3/4		

ALUMINUM O-RING FITTINGS

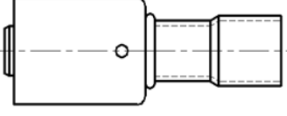



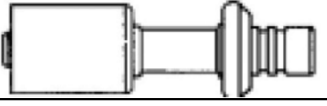
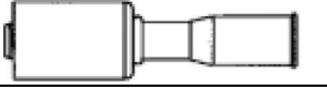
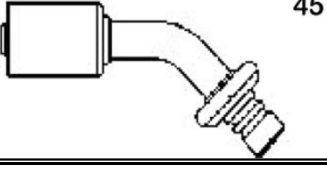
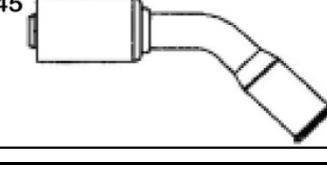
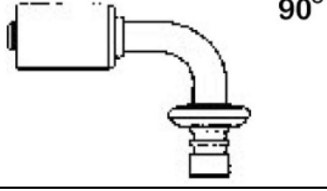
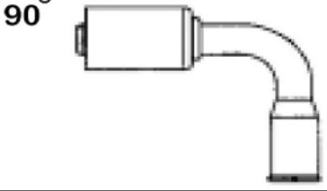
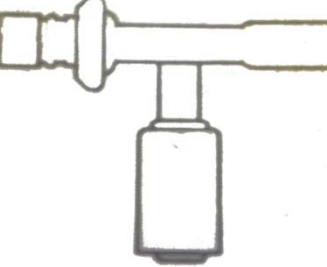

ALUMINUM SPLICERS					
3 BARB SPLICERS	PART NUMBER	HOSE SIZE	HOSE SIZE	PART NUMBER	BEADLOCK SPLICERS
	45-2778	#6	#6	45-3747	
	45-2779	#8	#8	45-3749	
	45-2780	#10	#10	45-3751	
	45-2781	#12	#12	45-3753	
STEP UP/DOWN SPLICER	45-2782	#6	#8	45-3755	STEP UP/DOWN SPLICER
	45-2783	#8	#10	45-3757	
	45-2784	#10	#12	45-3759	
	45-3389	#6	#6	45-3772	
	45-3390	#8	#8	45-3773	
	45-3391	#10	#10	45-3774	
	45-3392	#12	#12	45-3775	
	45-2855	#6	#6	45-3761	
	45-2849	#8	#8	45-3763	
	45-2789	#10	#10	45-3765	
	45-2790	#12	#12	45-3767	
	45-2785	#6	#6	45-3799	
	45-2786	#8	#8	45-3801	
	45-2787	#10	#10	45-3803	
	45-2788	#12	#12	45-3804	
WELD ON ALUMINUM FITTINGS					
BARB WELD ON INNER	PART NUMBER	HOSE SIZE	FITTING SIZE	PART NUMBER	BEADLOCK WELD ON FITTING WITH FERRULE
	45-3189	#6	3/8	45-4995	
	45-3190	#8	1/2	45-4996	
	45-3191	#10	5/8	45-4997	
	45-3192	#12	3/4	45-4998	
BARB WELD ON OUTER	PART NUMBER	HOSE SIZE	FITTING SIZE	PART NUMBER	FERRULES
	45-3241	#6	3/8	45-2931	
	45-3242	#8	1/2	45-2932	
	45-3243	#10	5/8	45-2933	
	45-3244	#12	3/4	45-2934	
ALUMINUM FITTINGS					

SPRINGLOCK FITTINGS

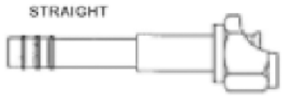
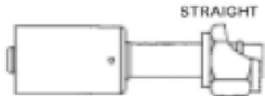
BEADLOCK MALE SPRINGLOCK	PART NUMBER	HOSE SIZE	FITTING SIZE	PART NUMBER	BEADLOCK FEMALE SPRINGLOCK
STRAIGHT 	44-2396 44-2397 44-2398 44-2399	#6 #8 #10 #12	3/8 1/2 5/8 3/4	44-2378 44-2379 44-2380 44-2381	STRAIGHT 
STEP UP / STEP DOWN	44-2401 44-2400	#6 #12	1/2 5/8	45-2383 45-2382	STEP UP / STEP DOWN
 45°	44-2402 44-2403 44-2404 44-2405	#6 #8 #10 #12	3/8 1/2 5/8 3/4	44-2384 44-2385 44-2386 44-2387	45° 
STEP UP / STEP DOWN	44-2407 44-2406	#6 #12	1/2 5/8	44-2389 44-2388	STEP UP / STEP DOWN
 90°	44-2408 44-2409 44-2410 44-2411	#6 #8 #10 #12	3/8 1/2 5/8 3/4	44-2390 44-2391 44-2392 44-2393	90° 
STEP UP / STEP DOWN	44-2413 44-2412	#6 #12	1/2 5/8	44-2395 44-2394	STEP UP / STEP DOWN
		#6 #10 #10	#8 #10 #12	44-2414 44-2415 44-2416	

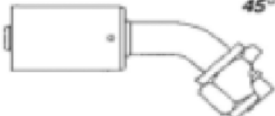
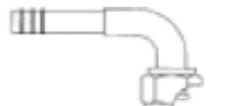
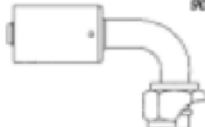
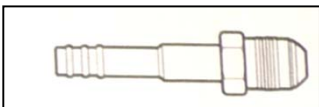
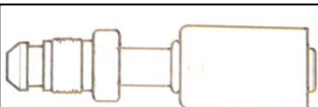
SPRINGLOCK FITTINGS

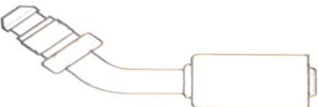
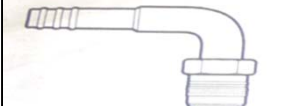
FLARE FITTINGS

STANDARD 3 BARB FEMALE FLARE	PART NUMBER	HOSE SIZE	FITTING SIZE	PART NUMBER	BEADLOCK FEMALE FLARE
STRAIGHT 	45-2650 45-2651 45-2652 45-2653	#6 #8 #10 #12	3/8 1/2 5/8 3/4	45-3473 45-3474 45-3475 45-3476	STRAIGHT 
45° 	45-2654 45-2655 45-2656 45-2657	#6 #8 #10 #12	3/8 1/2 5/8 3/4	45-3479 45-3480 45-3481 45-3482	45° 
90° 	45-2658 45-2659 45-2660 45-2661	#6 #8 #10 #12	3/8 1/2 5/8 3/4	45-3484 45-3485 45-3486 45-3487	90° 
3 BARB FEMALE FLARE STEP UP/ STEP DOWN	PART NUMBER	HOSE SIZE	FITTING SIZE	PART NUMBER	BEADLOCK FEMALE FLARE STEP UP / STEP DOWN
STRAIGHT	45-2671 45-2672 45-2673 45-2674 45-2675 45-2676	#8 #6 #10 #8 #12 #10	#6 #8 #8 #10 #10 #12	45-3529 45-3477 45-3531 45-3478	STRAIGHT
45 DEGREE	45-2677 45-2678 45-2679 45-2680 45-2681	#8 #10 #12 #6 #8	#6 #8 #10 #8 #10	45-3533 45-3535 45-4537 45-3483	45 DEGREE
90 DEGREE	45-2723 45-2724 45-2725 45-2726 45-2727 45-3194	#8 #6 #10 #8 #10 #12	#6 #8 #8 #10 #12 #10	45-3539 45-3489 45-3541 45-3488	90 DEGREE
STANDARD 3 BARB MALE FLARE	PART NUMBER	HOSE SIZE	FITTING SIZE	PART NUMBER	BEADLOCK MALE FLARE
	45-2638 45-2639 45-4640 45-2641	#6 #8 #10 #12	3/8 1/2 5/8 3/4	45-3278 45-3279 45-3280 45-3281	
	45-2642 45-2643 45-2644 45-2645	#6 #8 #10 #12	3/8 1/2 5/8 3/4	45-4677 45-4678 45-4675 45-4676	
	45-2646 45-2647 45-2648 45-2649	#6 #8 #10 #12	3/8 1/2 5/8 3/4	45-4681 45-4682 45-4679 45-4680	

METRIC FITTINGS

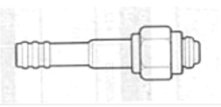
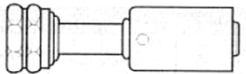
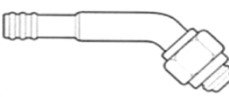
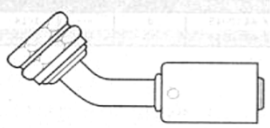
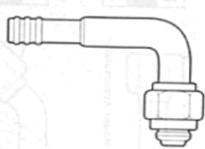
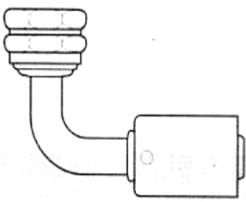
STANDARD 3 BARB FEMALE O-RING	PART NUMBER	HOSE SIZE	FITTING SIZE	PART NUMBER	BEADLOCK FEMALE O-RING
	45-2994	#6	M14	45-3699	
	45-3068	#6	M16	45-3701	
	N/A	#6	M18	45-3703	
	N/A	#6	M20	45-3705	
	45-3070	#8	M20	45-3707	
	45-3271	#10	M22	45-3709	
	N/A	#10	M24	45-3711	
	N/A	#12	M27	45-3713	
		#10	M24	45-3939	WITH R-134A SERVICE PORT
		#8	M24	45-4338	STRAIGHT DUAL O-RING
		#10	M24	45-4340	
		#12	M27	45-4342	
	45-3072	#6	M14	45-3715	
	45-3074	#6	M16	45-3717	
	N/A	#6	M18	45-3719	
	N/A	#6	M20	45-3721	
	45-3076	#8	M20	45-3723	
	45-3273	#10	M22	45-3725	
	N/A	#10	M24	45-3727	
	N/A	#12	M27	45-3729	
		#8	M24	45-4344	45 DEGREE DUAL O-RING
		#10	M24	45-4346	
		#12	M27	45-4348	
	45-2996	#6	M14	45-3731	
	45-3078	#6	M16	45-3733	
	N/A	#6	M18	45-3735	
	N/A	#6	M20	45-3737	
	45-3080	#8	M20	45-3739	
	45-3275	#10	M22	45-3741	
	N/A	#10	M24	45-3743	
	N/A	#12	M27	45-3745	
		#8	M24	45-4350	90 DEGREE DUAL O-RING
		#10	M24	45-4352	
		#12	M27	45-4354	

METRIC FITTINGS

REFRIGERANT HOSE STANDARD SIZES

HOSE END SIZING

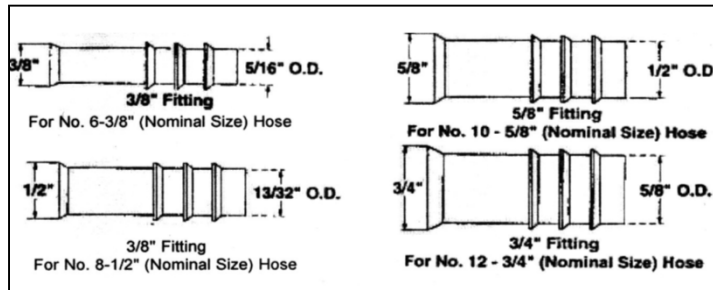

REFRIGERANT HOSE SIZING

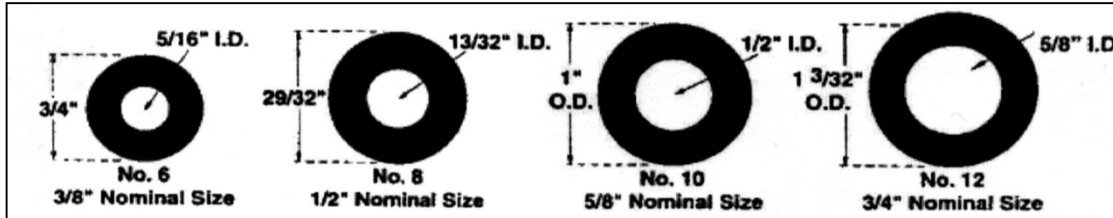

BARRIER HOSE

SIZE	I.D.	25'	50'	BULK SPOOL
#6	5/16"	41-2506	41-2510	45-2514
#8	13/32"	41-2507	41-2511	41-2515
#10	1/2"	41-2508	41-2512	41-2516
#12	5/8"	41-2509	41-2513	41-2517

HOSE CRIMP FERRULES

SIZE	PART #	
#6	45-2931	
#8	45-2932	
#10	45-2933	
#12	45-2934	

REFRIGERANT HOSE CLAMPS

#6 & #8	31-2101	
#10 & #12	31-2102	

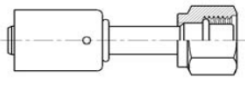
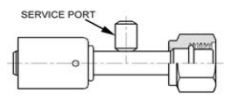
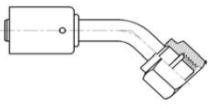
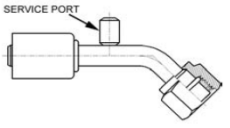
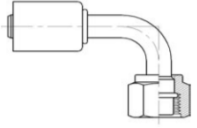
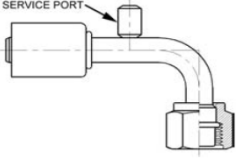
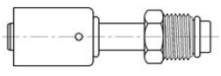
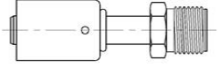

REDUCED BARRIER ALUMINUM FITTINGS

BEADLOCK FEMALE O-RING	PART NUMBER	HOSE SIZE	FITTING SIZE	PART NUMBER	BEADLOCK FEMALE O-RING WITH 134A CHARGE PORT
	45-4029 45-4031 45-4033 45-4397	#6 #8 #10 #12	3/8 1/2 5/8 3/4	45-4407 45-4409 45-4411 45-4413	
STEP UP/ STEP DOWN	45-4399 45-4401	#12 #6	5/8 1/2	45-4415 N/A	STEP UP/ STEP DOWN
	45-4035 45-4037 45-4039 45-4403	#6 #8 #10 #12	3/8 1/2 5/8 3/4	N/A 45-4041 45-4043 N/A	
STEP UP/ STEP DOWN	45-4405	#12	5/8	N/A	STEP UP/ STEP DOWN
	45-4046 45-4048 45-4050 45-4417	#6 #8 #10 #12	3/8 1/2 5/8 3/4	45-4058 45-4060 45-4062 45-4427	
STEP UP/ STEP DOWN	45-4419 45-4421	#12 #6	5/8 1/2	45-4429 N/A	STEP UP/ STEP DOWN
BEADLOCK MALE O-RING	PART NUMBER	HOSE SIZE	FITTING SIZE	PART NUMBER	BEADLOCK MALE INSERT O-RING
	45-4433 45-4435 45-4437 45-4439	#6 #8 #10 #12	3/8 1/2 5/8 3/4	45-4072 45-4074 N/A N/A	
STEP UP/ STEP DOWN	45-4441	#12	5/8	N/A	STEP UP/ STEP DOWN

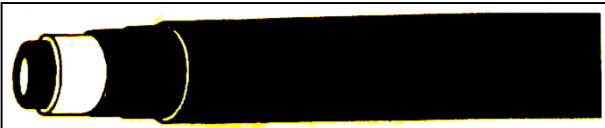
REDUCED BARRIER HOSE

SIZE	50'	BULK		
#6	41-13410 50	41-13410		
#8	41-13411 50	41-13411		
#10	41-13412 50	41-13412		
#12	41-13413 50	41-13413		

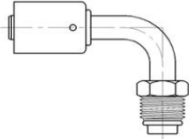
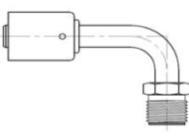
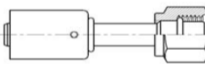
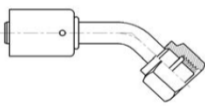
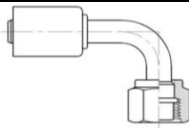
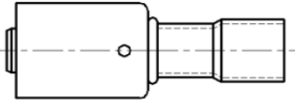
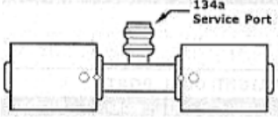
REDUCED BARRIER ALUMINUM FITTINGS

BEADLOCK MALE O-RING	PART NUMBER	HOSE SIZE	FITTING SIZE	PART NUMBER	BEADLOCK MALE INSERT O-RING
	45-4443 45-4445 45-4447 45-4449	#6 #8 #10 #12	3/8 1/2 5/8 3/4	N/A 45-4076 N/A N/A	
STEP UP/ STEP DOWN	45-4451	#12	5/8	N/A	STEP UP/ STEP DOWN
METRIC REDUCED BARRIER FEMALE O-RING	PART NUMBER	HOSE SIZE	FITTING SIZE		
	45-5015	#6	M20		
	45-5016 45-5017 45-5018 45-5019	#6 #8 #10 #12	M18 M20 M20 M27		
	45-5020 45-5021 45-5022	#6 #8 #12	M18 M20 M27		
BEADLOCK WELD ON FITTING WITH FERRULE	PART NUMBER	HOSE SIZE	FITTING SIZE	PART NUMBER	BEADLOCK SPLICER WITH 134A CHARGE PORT
	45-4600 45-4601 45-4602 45-4603	#6 #8 #10 #12	3/8 1/2 5/8 3/4	45-4088 45-4090 45-4092 45-4461	
FERRULES	PART NUMBER	HOSE SIZE	HOSE SIZE	PART NUMBER	BEADLOCK SPLICER
	45-2931RB 45-2932RB 45-2933RB 45-2934RB	#6 #8 #10 #12	#6 #8 #10 #12	45-4078 45-4080 45-4082 45-4453	
		#8 #10 #12	3/8 1/2 5/8	45-4455 45-4457 45-4459	STEP UP/ STEP DOWN SPLICER

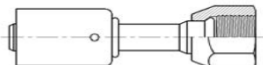
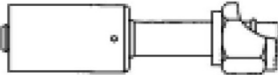
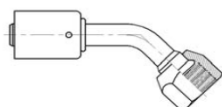
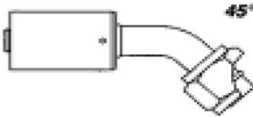
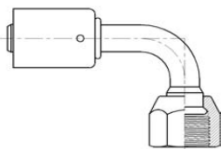
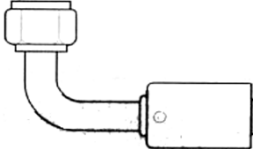
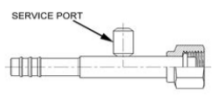
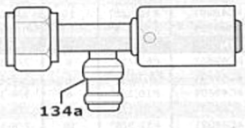
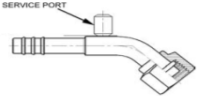
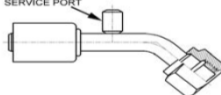
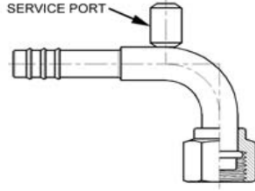
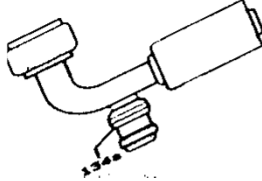

REDUCED BARRIER ALUMINUM FITTINGS

STEEL FITTINGS

BEADLOCK FEMALE FLARE	PART NUMBER	HOSE SIZE	FITTING SIZE	PART NUMBER	BEADLOCK FEMALE O-RING
	45-3490STL 45-3491STL 45-3492STL 45-3493STL	#6 #8 #10 #12	3/8 1/2 5/8 3/4	45-3502STL 45-3503STL 45-3504STL 45-3505STL	STRAIGHT 
STEP UP/ STEP DOWN FEMALE O-RING	N/A N/A N/A N/A	#6 #8 #10 #12	3/8 1/2 5/8 3/4	45-3506STL 45-3507STL 45-3559STL 45-3561STL 45-3563STL	STEP UP/ STEP DOWN FEMALE O-RING
	45-3494STL 45-3495STL 45-3496STL 45-3497STL	#6 #8 #10 #12	3/8 1/2 5/8 3/4	45-3508STL 45-3509STL 45-3510STL 45-3511STL	45° 
	45-3498STL N/A 45-3500STL 45-3501STL	#6 #8 #10 #12	3/8 1/2 5/8 3/4	45-3512STL 45-3513STL 45-3514STL 45-3515STL	
STEP UP/ STEP DOWN FEMALE O-RING	N/A N/A N/A N/A N/A	#8 #6 #10 #12 #10	3/8 1/2 1/2 5/8 3/4	N/A N/A 45-3601STL 45-3516STL 45-3603STL	STEP UP/ STEP DOWN FEMALE O-RING
3 BARB FEMALE O-RING W/R134 CHARGING PORT	PART NUMBER	HOSE SIZE	FITTING SIZE	PART NUMBER	BEADLOCK FEMALE O-RING W/R134 CHARGING PORT
	45-4687STL 45-4689STL 45-4684STL 45-4686STL N/A	#6 #8 #10 #12 #12	3/8 1/2 5/8 5/8 3/4	45-3572STL 45-3573STL 45-3574STL 45-3575STL 45-4707STL	
	N/A N/A N/A N/A	#6 #8 #10 #12	3/8 1/2 5/8 3/4	N/A N/A N/A N/A	SERVICE PORT 
	45-4702STL N/A 45-4699STL N/A	#6 #8 #10 #12	3/8 1/2 5/8 3/4	45-3612STL 45-3613STL 45-3614STL N/A	SERVICE PORT 

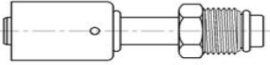
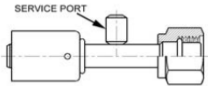
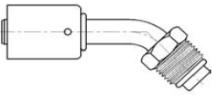
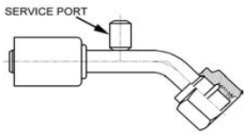
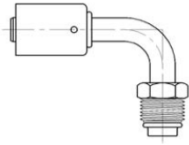
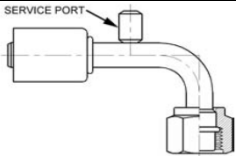

STEEL FITTINGS

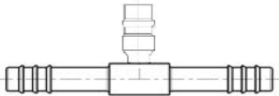
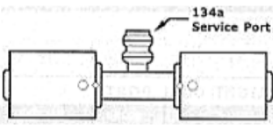
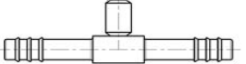
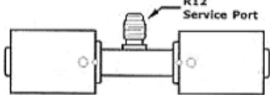
STEEL FITTINGS

BEADLOCK MALE O-RING	PART NUMBER	HOSE SIZE	FITTING SIZE	PART NUMBER	BEADLOCK FEMALE O-RING WITH R12 CHARGE PORT
	45-3490STL 45-3491STL 45-3492STL 45-3493STL	#6 #8 #10 #12	3/8 1/2 5/8 3/4	45-1301STL 45-1302STL 45-1303STL N/A	
	45-3494STL 45-3495STL 45-3496STL 45-3497STL	#6 #8 #10 #12	3/8 1/2 5/8 3/4	N/A N/A N/A N/A	
	45-3498STL N/A 45-3500STL 45-3501STL	#6 #8 #10 #12	3/8 1/2 5/8 3/4	45-1321STL 45-1322STL 45-1323STL 45-1324STL	
3 BARB SPLICER	PART NUMBER	HOSE SIZE	HOSE SIZE	PART NUMBER	BEADLOCK SPLICER
	N/A N/A N/A N/A	#6 #8 #10 #12	#6 #8 #10 #12	45-3747STL 45-3749STL 45-3751STL 45-3753STL	
3 BARB SPLICER WITH 134A CHARGE PORT	PART NUMBER	HOSE SIZE	HOSE SIZE	PART NUMBER	BEADLOCK SPLICER WITH 134A CHARGE PORT
	N/A N/A N/A N/A	#6 #8 #10 #12	#6 #8 #10 #12	45-3772STL 45-3773STL 45-3774STL 45-3775STL	
3 BARB SPLICER WITH R12 CHARGE PORT	PART NUMBER	HOSE SIZE	HOSE SIZE	PART NUMBER	BEADLOCK SPLICER WITH R12 CHARGE PORT
	N/A N/A N/A N/A	#6 #8 #10 #12	#6 #8 #10 #12	45-3761STL 45-3763STL 45-3765STL 45-3767STL	

STEEL FITTINGS

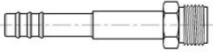
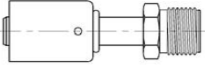
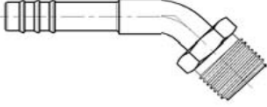
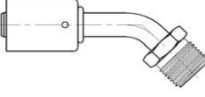
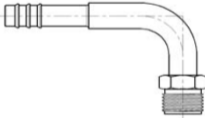
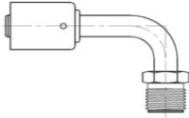
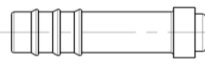
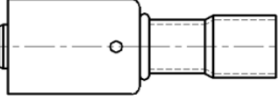
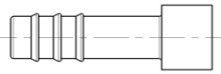
STEEL FITTINGS

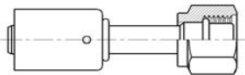
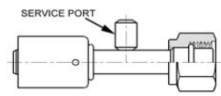
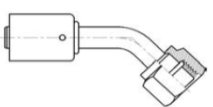
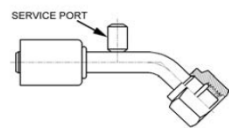
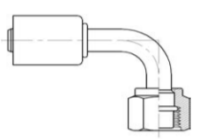
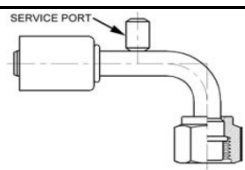
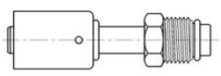
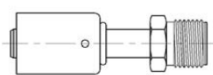

BARB MALE INSERT O-RING	PART NUMBER	HOSE SIZE	FITTING SIZE	PART NUMBER	BEADLOCK MALE INSERT O-RING
	N/A N/A N/A N/A	#6 #8 #10 #12	3/8 1/2 5/8 3/4	45-1801STL 45-1802STL 45-1803STL 45-1804STL	
	N/A N/A N/A N/A	#6 #8 #10 #12	3/8 1/2 5/8 3/4	45-1811STL 45-1812STL 45-1813STL 45-1814STL	
	N/A N/A N/A N/A	#6 #8 #10 #12	3/8 1/2 5/8 3/4	45-1821STL 45-1822STL 45-1823STL 45-1824STL	
BARB WELD ON INNER	PART NUMBER	HOSE SIZE	FITTING SIZE	PART NUMBER	BEADLOCK WELD ON FITTING WITH FERRULE
	45-3019STL 45-3020STL 45-3021STL 45-3022STL N/A	#6 #8 #10 #12 #12	3/8 1/2 5/8 3/4 5/8	45-3816STL 45-3817STL 45-3818STL 45-3819STL 45-3820STL	
BARB WELD ON OUTER	PART NUMBER	HOSE SIZE	FITTING SIZE	PART NUMBER	FERRULES
	45-3236STL 45-3237STL 45-3238STL 45-3239STL	#6 #8 #10 #12	3/8 1/2 5/8 3/4	45-2931 45-2932 45-2933 45-2934	
STEEL FITTINGS					

REDUCED BARRIER STEEL FITTINGS

BEADLOCK FEMALE O-RING	PART NUMBER	HOSE SIZE	FITTING SIZE	PART NUMBER	BEADLOCK FEMALE O-RING WITH 134A CHARGE PORT
	45-4204STL 45-4205STL 45-4206STL 45-4207STL	#6 #8 #10 #12	3/8 1/2 5/8 3/4	45-4200STL 45-4201STL 45-4202STL 45-4203STL	
STEP UP/ STEP DOWN	45-4208STL 45-4209STL 45-4210STL N/A	#8 #10 #12 #12	3/8 1/2 5/8 3/4	N/A N/A N/A N/A	STEP UP/ STEP DOWN
	45-4214STL 45-4215STL 45-4216STL 45-4217STL	#6 #8 #10 #12	3/8 1/2 5/8 3/4	45-4211STL 45-4212STL 45-4213STL N/A	
STEP UP/ STEP DOWN	45-4218STL 45-4219STL 45-4220STL N/A	#8 #10 #12 #12	3/8 1/2 5/8 3/4	N/A N/A N/A N/A	STEP UP/ STEP DOWN
	45-4226STL 45-4227STL 45-4228STL 45-4229STL	#6 #8 #10 #12	3/8 1/2 5/8 3/4	45-4221STL 45-4222STL 45-4223STL 45-4224STL	
STEP UP/ STEP DOWN	45-4230STL 45-4231STL 45-4232STL N/A	#8 #10 #12 #12	3/8 1/2 5/8 3/4	N/A N/A N/A N/A	STEP UP/ STEP DOWN
BEADLOCK MALE O-RING	PART NUMBER	HOSE SIZE	FITTING SIZE	PART NUMBER	BEADLOCK MALE INSERT O-RING
	45-4234STL 45-4235STL 45-4236STL 45-4237STL	#6 #8 #10 #12	3/8 1/2 5/8 3/4	45-4253STL 45-4254STL 45-4255STL 45-4256STL	
STEP UP/ STEP DOWN	45-4238STL 45-4239STL 45-4240STL N/A	#8 #10 #12 #12	3/8 1/2 5/8 3/4	N/A N/A N/A N/A	STEP UP/ STEP DOWN

REDUCED BARRIER STEEL FITTINGS

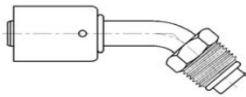
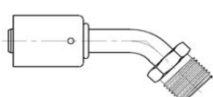
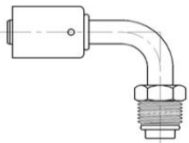
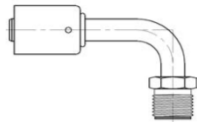
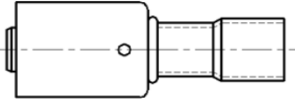
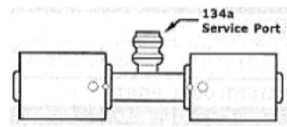
REDUCED BARRIER STEEL FITTINGS







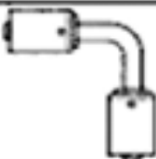
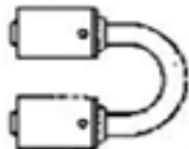

BEADLOCK MALE O-RING	PART NUMBER	HOSE SIZE	FITTING SIZE	PART NUMBER	BEADLOCK MALE INSERT O-RING
	45-4241STL 45-4242STL 45-4243STL N/A	#6 #8 #10 #12	3/8 1/2 5/8 3/4	N/A N/A N/A N/A	
STEP UP/ STEP DOWN	45-4244STL 45-4245STL 45-4246STL N/A	#8 #10 #12 #12	3/8 1/2 5/8 3/4	N/A N/A N/A N/A	STEP UP/ STEP DOWN
	45-4247STL 45-4248STL 45-4249STL N/A	#6 #8 #10 #12	3/8 1/2 5/8 3/4	N/A N/A N/A 45-4233STL	
STEP UP/ STEP DOWN	45-4250STL 45-4251STL 45-4252STL N/A	#8 #10 #12 #12	3/8 1/2 5/8 3/4	N/A N/A N/A N/A	STEP UP/ STEP DOWN
BEADLOCK WELD ON FITTING WITH FERRULE	PART NUMBER	HOSE SIZE	FITTING SIZE	PART NUMBER	BEADLOCK SPLICER WITH 134A CHARGE PORT
	45-4600STL 45-4601STL 45-4602STL 45-4603STL	#6 #8 #10 #12	3/8 1/2 5/8 3/4	45-4257STL 45-4258STL 45-4259STL 45-4260STL	
FERRULES	PART NUMBER	HOSE SIZE	HOSE SIZE	PART NUMBER	BEADLOCK SPLICER
	45-2931RB 45-2932RB 45-2933RB 45-2934RB	#6 #8 #10 #12	#6 #8 #10 #12	45-4261STL 45-4262STL 45-4263STL 45-4267STL	
		#8 #10 #12	#6 #8 #10	45-4264STL 45-4265STL 45-4266STL	STEP UP/ STEP DOWN

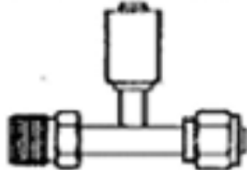
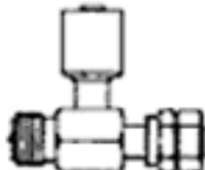
REDUCED BARRIER STEEL FITTINGS

REFRIGERANT FITTINGS





BEADLOCK SPLICER	PART NUMBER	HOSE SIZE	FITTING SIZE	PART NUMBER	BEADLOCK SPLICER
90° SPLICER 	45-3783 45-3785 45-3787 45-3789	#6 #8 #10 #12	3/8 1/2 5/8 3/4	45-3791 45-3793 45-3795 45-3797	 180° SPLICER

SPECIAL FITTINGS - ADAPTER/SPLICER/TEE FITTINGS



UNIVERSAL "T" SPLICER ENGLISH THREADED FITTING  <table style="margin-left: auto; margin-right: auto;"> <thead> <tr> <th>PART NUMBER</th> <th>HOSE SIZE</th> <th>FITTING SIZE</th> </tr> </thead> <tbody> <tr> <td>45-3809</td> <td>#6</td> <td>#6</td> </tr> <tr> <td>45-3811</td> <td>#8</td> <td>#8</td> </tr> <tr> <td>45-3813</td> <td>#10</td> <td>#10</td> </tr> <tr> <td>45-3815</td> <td>#10</td> <td>#12</td> </tr> </tbody> </table>	PART NUMBER	HOSE SIZE	FITTING SIZE	45-3809	#6	#6	45-3811	#8	#8	45-3813	#10	#10	45-3815	#10	#12	CHRYSLER "T" SPLICER SUCTION LINE METRIC THREADS  <table style="margin-left: auto; margin-right: auto;"> <thead> <tr> <th>PART NUMBER</th> <th>HOSE SIZE</th> <th>FITTING SIZE</th> </tr> </thead> <tbody> <tr> <td>44-2375</td> <td>#10</td> <td>M22</td> </tr> </tbody> </table>	PART NUMBER	HOSE SIZE	FITTING SIZE	44-2375	#10	M22
PART NUMBER	HOSE SIZE	FITTING SIZE																				
45-3809	#6	#6																				
45-3811	#8	#8																				
45-3813	#10	#10																				
45-3815	#10	#12																				
PART NUMBER	HOSE SIZE	FITTING SIZE																				
44-2375	#10	M22																				
FORD SPRINGLOCK #6 M.I.O. - TEE <small>10 M.M.S. & SPRING HOLES DEC:</small> <small>44-2464 #6 M.S.L. #6 F.S.L. x #6 M.I.O.</small> <small>44-2463 #6 M.S.L. #6 F.S.L. x #6 M.I.O.</small> 	BEADLOCK SPLICER W/SHOULDER  <p style="text-align: right;">45-3778 #6</p>																					
METRIC ADAPTER  <p>45-3082 - 3/8 FF x 16mm MIO 45-3084 - 1/2 FF x 20mm MIO</p>	SELF-SEALING COUPLING  <p>45-2789</p>	VACUUM PUMP ADAPTER ADAPTS R12 PUMP TO 134a HOSE  <p>43-MT0433</p>																				
TUBO TO ROTOLOCK ADAPTERS  <p>45-3213</p>	ACCUMULATOR ADAPTER 3/4 MALE O-RING INSERT x 3/4 FEMALE O-RING  <p>44-2262</p>	VIT TO COOT ADAPTER  <p>44-2303</p>																				

MISCELLANEOUS ACCESSORIES FOR R134a RETROFIT

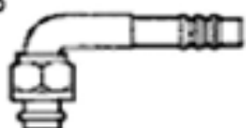
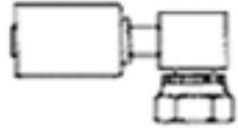



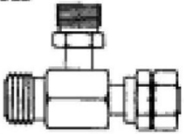
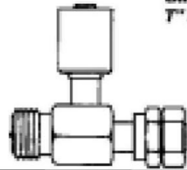
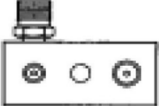

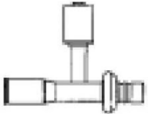
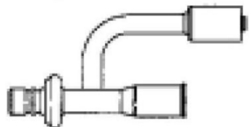

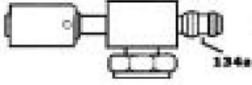
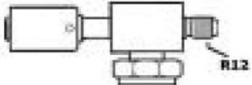

HIGH SIDE SERVICE PORT CAP FOR R134a  <p>43-MT0069</p>	LOW SIDE SERVICE PORT CAP FOR R134a  <p>43-MT0061</p>	VALVE CORE R12 & R134a  <p>43-MT0064</p>
---	--	---

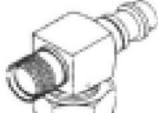
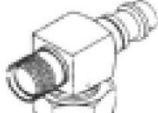
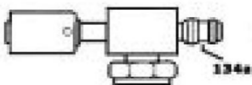
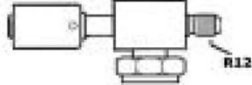
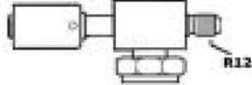
SPECIAL FITTINGS 3 BARB COMPRESSION	PART NUMBER	HOSE SIZE	FITTING SIZE	PART NUMBER	SPECIAL FITTINGS BEADLOCK COMPRESSION
STRAIGHT 	45-2961 45-2962 45-2963 45-2964	#6 #8 #10 #12	3/8 1/2 5/8 3/4	45-3644 45-3645 45-3646 45-3647	 STRAIGHT
90° 	45-2977 45-2978 45-2979 45-3005	#6 #8 #10 #12	3/8 1/2 5/8 3/4	45-3659 45-3661 45-3663 45-3665	 90°
STANDARD 3 BARB FEMALE O-RING SHORT DROP	PART NUMBER	HOSE SIZE	FITTING SIZE	PART NUMBER	BEADLOCK FEMALE O-RING SHORT DROP
90° 	45-5402 45-5403	#8 #10	1/2 5/8	45-7084 45-7085	 90°

REFRIGERANT FITTINGS

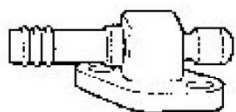
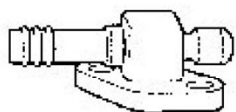
SPECIAL ADAPTERS TEES	PART NUMBER	HOSE SIZE	FITTING SIZE	PART NUMBER	SPECIAL ADAPTERS BEADLOCK SPLICERS
 <p>GM METRIC THREADED "T"</p>	44-2452 44-2453	#6 #10	M20 M27	44-2432 44-2433	 <p>GM METRIC "T" SPLICER</p>
 <p>CHRYSLER CONDENSER LIQUID "T"</p>	44-2434	#6	CNDSR	44-2377	 <p>CHRYSLER "T" SPLICER LIQUID LINE</p>
 <p>FORD "T" SPLICER LIQUID LINE KIT-RINGS & SPRING INCLUDED</p>	44-2414 44-2416	#6 #10	#8 #12	44-2417 NA	 <p>FORD "T" SPLICER LIQUID LINE KIT-RINGS & SPRING INCLUDED</p>





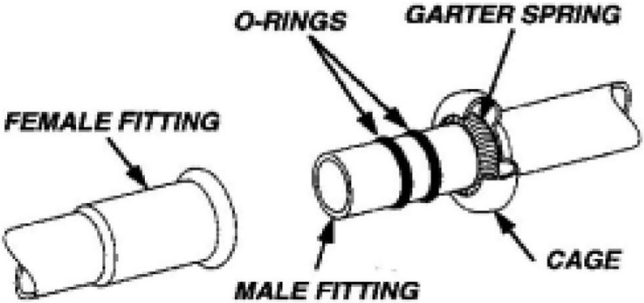
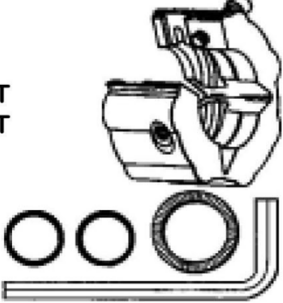

SPECIAL FITTINGS - COMPRESSOR

<p>FITS YORK TUBE-O COMPRESSORS</p> <p>44-2369 #8 BEADLOCK 44-2370 #10 BEADLOCK</p>  <p>44-2372 #8 BEADLOCK 44-2373 #10 BEADLOCK</p>  <p>44-2151 #8 MALE O-RING</p>  <p>44-2152 #10 MALE O-RING</p>  <p>44-2442 #8 O-RING</p>  <p>44-2443 #10 O-RING</p> 	<p>FITS YORK ROTOLock COMPRESSORS</p> <p>44-2365 #8 BEADLOCK 44-2366 #10 BEADLOCK</p>  <p>44-2367 #8 BEADLOCK</p>  <p>44-2368 #10 BEADLOCK</p>  <p>44-2149 #8 MALE O-RING</p>  <p>44-2150 #10 MALE O-RING</p>  <p>44-2436 #8 O-RING</p>  <p>44-2437 #10 O-RING</p> 	<p>FITS YORK FLANGE HEAD COMPRESSORS</p> <p>44-2117 #8 BARB END</p>  <p>44-2118 #10 BARB END</p>  <p>44-2446 #8 MALE O-RING</p>  <p>44-2447 #10 MALE O-RING</p>  <p>O-RING TO FLARE ADAPTERS</p> <p>#6 45-2924 #8 45-2926 #10 45-3086 #12 45-3235</p> 
--	--	--

SPRINGLOCK COUPLING REPAIR KITS

 <p>O-RINGS GARTER SPRING FEMALE FITTING MALE FITTING CAGE</p>	<p>MT2101 #6 REPAIR KIT MT2102 #8 REPAIR KIT MT2103 #10 REPAIR KIT MT2104 #12 REPAIR KIT</p> <p>KIT INCLUDES: (1) SPRINGLOCK HOUSING (1) SPRINGLOCK SPRING (2) O-RINGS (1) ALLEN WRENCH</p> 
---	--

RETROFIT FITTINGS

R134a CONVERSION FITTINGS - FOR RETROFIT	PART NO.	PORT USAGE	THREAD SIZE	FITTING SIZE
CONVERTS R-12 SERVICE PORTS TO R134a PORTS 	45-3822	HI	3/16" (3/8" X 24)	16MM
CONVERTS R-12 SERVICE PORTS TO R134a PORTS 	45-3821	LO	1/4" (7/16" X 20)	13MM
CONVERTS R-12 SERVICE PORTS TO R134a PORTS 	45-3823	HI	1/4" (7/16" X 20)	16MM
CONVERTS R-12 SERVICE PORTS TO R134a PORTS 	45-3825	HI	3/16" (3/8"X24)	16MM
CONVERTS R-12 SERVICE PORTS TO R134a PORTS 	45-3824	LO	1/4" (7/16"X20)	13MM
CONVERTS R-12 SERVICE PORTS TO R134a PORTS 	45-3826	HI	1/4" (7/16" X20)	16MM

SPECIAL ADAPTERS - SPLICERS FOR RETROFIT

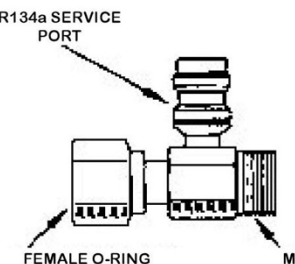
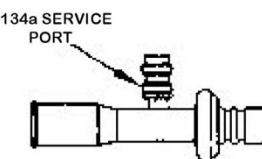
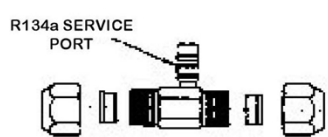
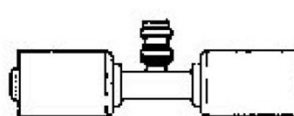
<p>UNIVERSAL SPLICER W/R134a SERVICE PORT</p>  <table border="1"> <thead> <tr> <th>PART NUMBER</th> <th>HOSE SIZE</th> <th>PORT TYPE</th> </tr> </thead> <tbody> <tr> <td>45-3827</td> <td>#6</td> <td>HIGH SIDE</td> </tr> <tr> <td>45-3828</td> <td>#8</td> <td>HIGH SIDE</td> </tr> <tr> <td>45-3829</td> <td>#10</td> <td>LOW SIDE</td> </tr> <tr> <td>45-3830</td> <td>#12</td> <td>LOW SIDE</td> </tr> </tbody> </table> <p>Labels: R134a SERVICE PORT, FEMALE O-RING, MALE INSERT O-RING</p>	PART NUMBER	HOSE SIZE	PORT TYPE	45-3827	#6	HIGH SIDE	45-3828	#8	HIGH SIDE	45-3829	#10	LOW SIDE	45-3830	#12	LOW SIDE	<p>FORD SPLICER W/R134a SERVICE PORT (O-RING & SPRING INCLUDED)</p>  <table border="1"> <thead> <tr> <th>PART NUMBER</th> <th>HOSE SIZE</th> <th>PORT TYPE</th> </tr> </thead> <tbody> <tr> <td>45-3835</td> <td>#6 SL</td> <td>HIGH SIDE</td> </tr> <tr> <td>45-3836</td> <td>#8 SL</td> <td>HIGH SIDE</td> </tr> <tr> <td>45-3837</td> <td>#10 SL</td> <td>LOW SIDE</td> </tr> <tr> <td>45-3838</td> <td>#12 SL</td> <td>LOW SIDE</td> </tr> </tbody> </table> <p>Label: R134a SERVICE PORT</p>	PART NUMBER	HOSE SIZE	PORT TYPE	45-3835	#6 SL	HIGH SIDE	45-3836	#8 SL	HIGH SIDE	45-3837	#10 SL	LOW SIDE	45-3838	#12 SL	LOW SIDE
PART NUMBER	HOSE SIZE	PORT TYPE																													
45-3827	#6	HIGH SIDE																													
45-3828	#8	HIGH SIDE																													
45-3829	#10	LOW SIDE																													
45-3830	#12	LOW SIDE																													
PART NUMBER	HOSE SIZE	PORT TYPE																													
45-3835	#6 SL	HIGH SIDE																													
45-3836	#8 SL	HIGH SIDE																													
45-3837	#10 SL	LOW SIDE																													
45-3838	#12 SL	LOW SIDE																													
<p>COMPRESSION FITTING SPLICER W/R134a SERVICE PORT</p>  <table border="1"> <thead> <tr> <th>PART NUMBER</th> <th>HOSE SIZE</th> <th>PORT TYPE</th> </tr> </thead> <tbody> <tr> <td>45-3831</td> <td>#6</td> <td>HIGH SIDE</td> </tr> <tr> <td>45-3832</td> <td>#8</td> <td>HIGH SIDE</td> </tr> <tr> <td>45-3833</td> <td>#10</td> <td>LOW SIDE</td> </tr> <tr> <td>45-3834</td> <td>#12</td> <td>LOW SIDE</td> </tr> </tbody> </table> <p>Label: R134a SERVICE PORT</p>	PART NUMBER	HOSE SIZE	PORT TYPE	45-3831	#6	HIGH SIDE	45-3832	#8	HIGH SIDE	45-3833	#10	LOW SIDE	45-3834	#12	LOW SIDE	<p>BEADLOCK SPLICER W/R134a SERVICE PORT</p>  <table border="1"> <thead> <tr> <th>PART NUMBER</th> <th>FROM HOSE SIZE</th> <th>TO HOSE SIZE</th> </tr> </thead> <tbody> <tr> <td>45-3772</td> <td>#6</td> <td>#6</td> </tr> <tr> <td>45-3773</td> <td>#8</td> <td>#8</td> </tr> <tr> <td>45-3774</td> <td>#10</td> <td>#10</td> </tr> <tr> <td>45-3775</td> <td>#12</td> <td>#12</td> </tr> </tbody> </table>	PART NUMBER	FROM HOSE SIZE	TO HOSE SIZE	45-3772	#6	#6	45-3773	#8	#8	45-3774	#10	#10	45-3775	#12	#12
PART NUMBER	HOSE SIZE	PORT TYPE																													
45-3831	#6	HIGH SIDE																													
45-3832	#8	HIGH SIDE																													
45-3833	#10	LOW SIDE																													
45-3834	#12	LOW SIDE																													
PART NUMBER	FROM HOSE SIZE	TO HOSE SIZE																													
45-3772	#6	#6																													
45-3773	#8	#8																													
45-3774	#10	#10																													
45-3775	#12	#12																													

POA UPGRADES

FORD

FAIRMONT/ MUSTANG	R-12	R-134
1976-74	43-2278	43-2279
FULL SIZE		
1976-73 before 1/2/76	43-2278	43-2279
1976 1/2/76-6/1/76	43-2244	43-2245
1976 after 6/1/76	43-2250	43-2251
GRANDA		
1975	43-2246	43-2247
LTD II		
before 2/1/79	43-2254	43-2255
after 2/1/79	43-2252	43-2253
PINTO		
1976-74	43-2278	43-2279
THUNDERBIRD		
1979 before 2/1/79	43-2252	43-2253
1979 after 2/1/79	43-2254	43-2255
1978-77 w/accum	43-2248	43-2249
1978-77 w/o accum	43-2250	43-2251
1976 after 6/1/76	43-2250	43-2251
1976-74 before 6/1/76	43-2242	43-2243
1973 after 4/15/73	43-2242	43-2243
1973 before 4/15/73	43-2278	43-2279
TORINO / RANCHERO		
1978 w/accumulator	43-2248	43-2249
1978-77 w/o accum	43-2250	43-2251
1976 from 1/2/76	43-2244	43-2245
1976-72 before 1/2/76	43-2278	43-2279
LINCOLN		
1979	43-2252	43-2253
1978-77	43-2250	43-2251
1976 after 6/1/76	43-2250	43-2251
1976 before 6/1/76	43-2244	43-2245
1975-74	43-2278	43-2279
1973	43-2242	43-2243
1972-70	43-2278	43-2279
MARK IV		
1979	43-2252	43-2253
1978-77	43-2250	43-2251
1976 after 6/1/76	43-2250	43-2251
1976-73 6/1/76-4/15/73	43-2242	43-2243
1973 before 4/15/73	43-2278	43-2279
VERSAILLES		
1980-77	43-2286	43-2287
MERCURY		
BOBCAT		
1980-78	43-2286	43-2287
1976-74	43-2278	43-2279
CAPRI		
1981-80	43-2254	43-2255
1979	43-2278	43-2279
COUGAR		
1979 after 2/1/79	43-2254	43-2255
1979 before 2/1/79	43-2252	43-2253

MERCURY CONT'D

COUGAR CONT'D	R-12	R-134
1978 w/accumulator	43-2248	43-2249
1978 w/o accumulator	43-2250	43-2250
1977	43-2248	43-2249
1976 w/accumulator	43-2244	43-2245
1976 w/o accumulator	43-2250	43-2251
1975-74	43-2278	43-2279
XR7		
1981-80	43-2256	43-2257
METEOR		
1979 after 10/2/78	43-2992	43-2993
1979 before 10/2/78	43-2254	43-2255
1978-77	43-2250	43-2251
1976 from 6/1/76	43-2244	43-2245
1976 before 6/1/76	43-2250	43-2251
1975-73	43-2278	43-2279
MONARCH		
1980-76	43-2286	43-2287
1975	43-2246	43-2247
MONTEGO		
1976-72	43-2278	43-2279
ZEPHYR		
1981-78	43-2254	43-2255
1977-76	43-2286	43-2287
1975	43-2246	43-2247
GENERAL MOTORS		
BUICK		
APOLLO		
1974-73	43-2278	43-2279
FULL SIZE		
1972-71	43-2242	43-2243
LASABRE/WILDCAT/ELECTRA		
1970-65.5	43-2242	43-2243
RIVIERA/SKYLARK		
1970-65.5	43-2278	43-2279
CADILLAC		
1973-66	43-2242	43-2243
CHEVROLET		
CAMARO		
1973-71	43-2442	43-2443
1970-67	43-2278	43-2279
CHEVELLE / CHEVY II/ NOVA / EL CAMINO		
1973-66	43-2278	43-2279
CORVETTE		
1972-67	43-2278	43-2279
FULL SIZE		
1973-67	43-2442	43-2443
MONTE CARLO		
1973-70	43-2278	43-2279
VEGA		
1971-70	43-2442	43-2443
ALL CHEVROLETS		
1966	43-2278	43-2279

CHEVROLET AND GMC TRUCKS

TRUCKS	R-12	R-134
1972-67	43-2278	43-2279
OLSMOBILE		
ALL except below		
1973-65.5	43-2442	43-2443
CUTLASS/F85		
1975.5-1973	43-2278	43-2279
CUSTOM CRUISER		
1973	43-2278	43-2279
OMEGA		
1974-73.5	43-2278	43-2279
1973.5-73	43-2442	43-2443
TORONADO		
1972-71	43-2442	43-2443
1970-66	43-2278	43-2279
PONTIAC		
FIREBIRD		
1969-67	43-2278	43-2279
GRAN PRIX		
1973-71	43-2278	43-2279
TEMPEST/LEMANDS		
1976-73	43-2242	43-2243
1972-65	43-2278	43-2279
TRANS AM		
1969	43-2442	43-2443
VENTURA W/POA		
1974	43-2442	43-2443
1973-1971	43-2278	43-2279
STV UPDATE KIT		
CHEVROLET		
IMPALA		
1965-62	43-2380 \$280.00	

**ALL POA VALVE
UPDATE KITS
\$325**

GENERAL MOTORS

P.O.A. UPGRADES

Converts POA system to a cycling clutch system as found in most late model vehicles.

Eliminates aggravating sticking internal piston. Saves gas milage and decreases length of load on the engine.

Easy to install!

R134a AND R-12 APPLICATIONS

\$325.00

Available for most GM and Ford versions of POA valves please see application on previous page

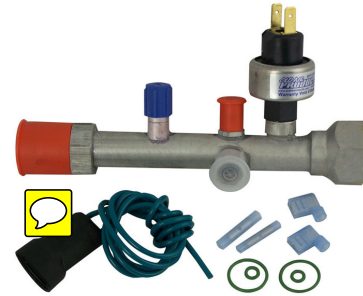

POA UPDATE KIT

43-2278 R12 \$325.00

43-2279 R134 \$325.00

V.I.R. P.O.A. CAPSULE

43-2225 \$93.00

V.I.R T.X.V. CAPSULE

43-2226 \$72.00

O-RING KIT V.I.R. 43-2270 \$4.00

V.I.R. MAINTENANCE KIT 43-2224 \$24.00

VIR SUBSTITUTION KIT

43-2277

ELIMINATES VIR PROBLEMS

MAKES R134 CONVERSION

EASIER

\$325.00

CHANGES SYSTEM TO

ORIFICE WITH PRESSURE

CYCLING SWITCH

